

**Графическое описание местоположения границ земель,
на которых располагаются леса,
расположенные в водоохраных зонах,
на территории
Гунибского участкового лесничества
Гунибского лесничества
Республики Дагестан**

Приложение № 8 к приказу Рослесхоза
от 27.02.2023 № 210

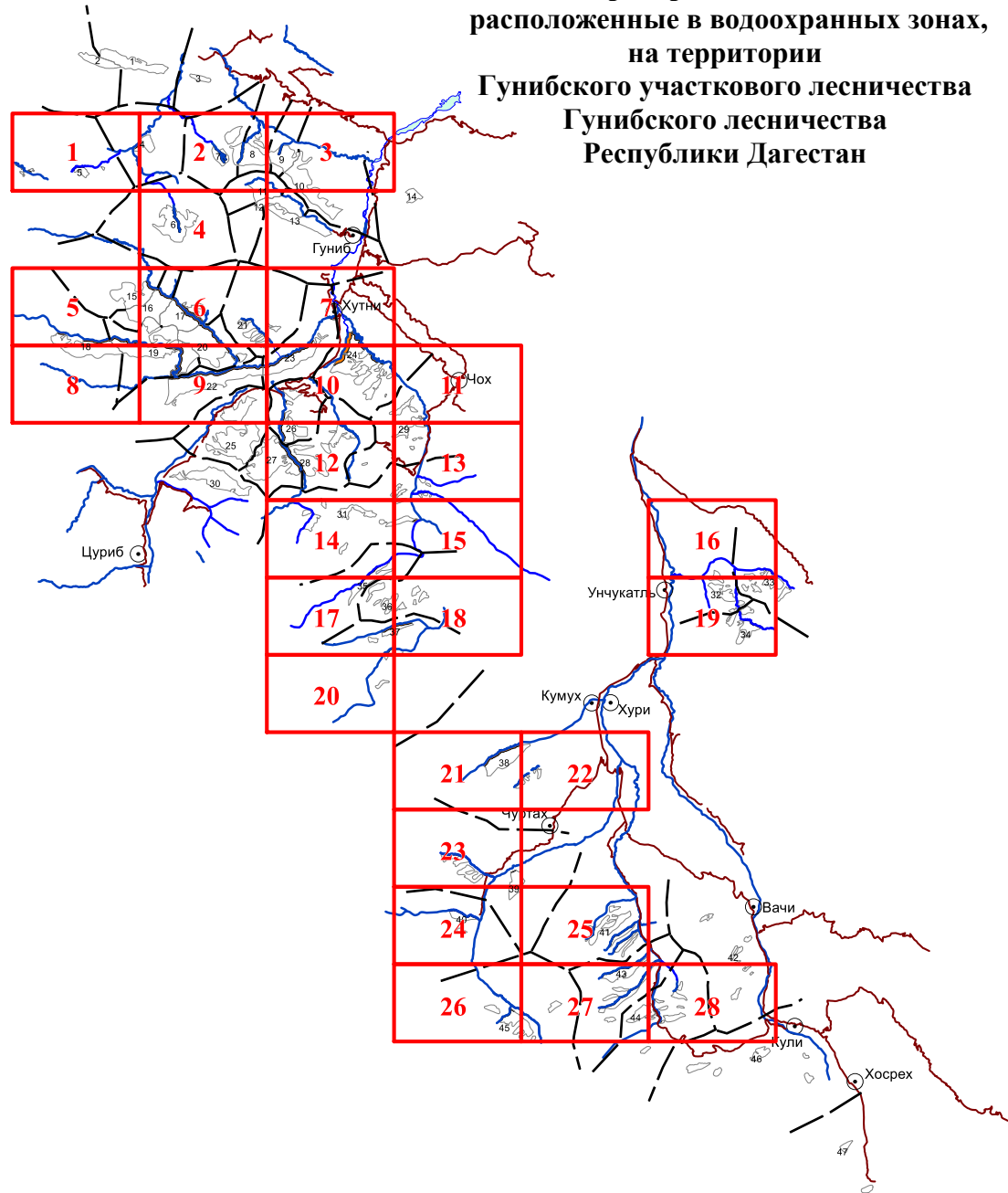

Условные обозначения:

- 3 - лесной квартал
- 3 - лист форматки
- - населенные пункты
- - реки
- - дороги
- леса, расположенные в водоохраных зонах

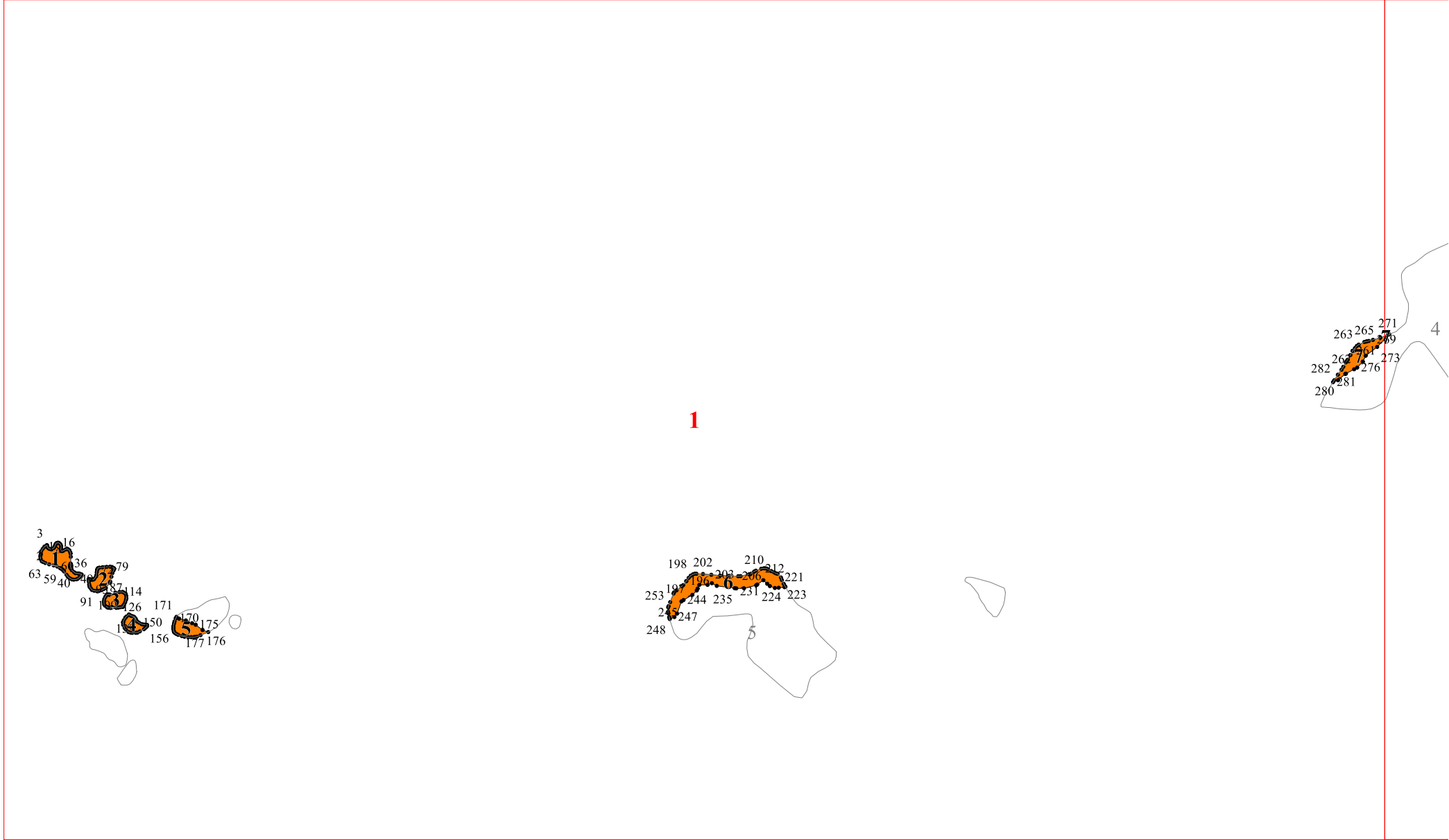

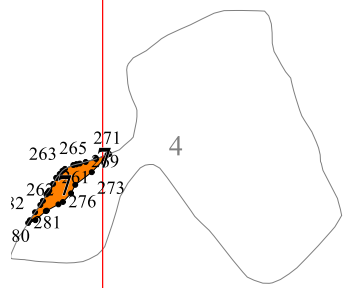

2

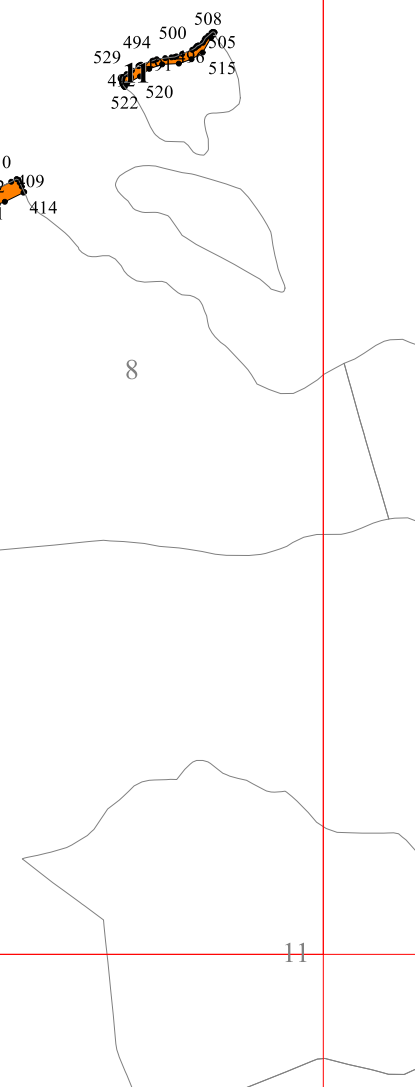
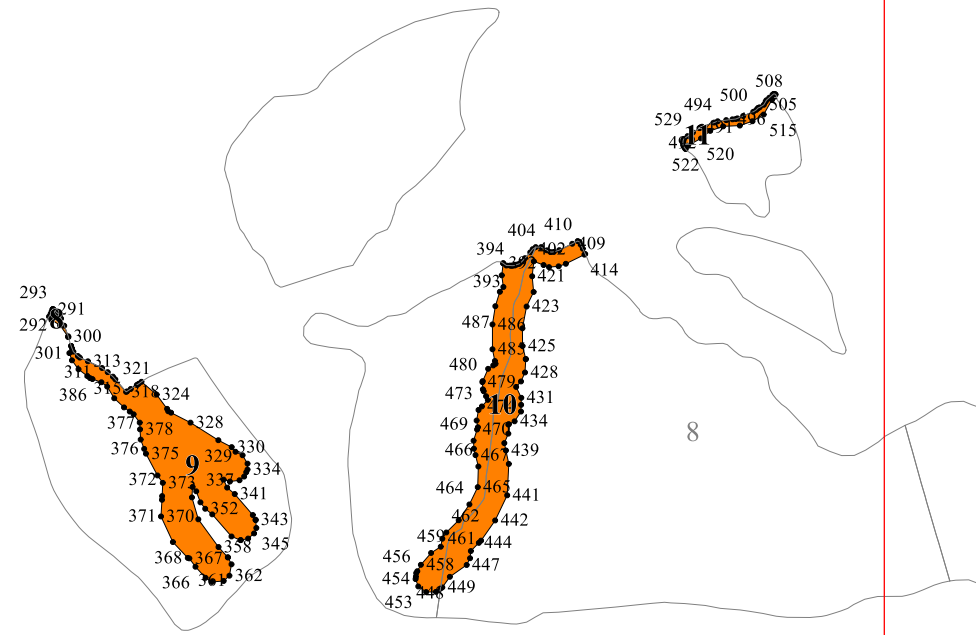

19

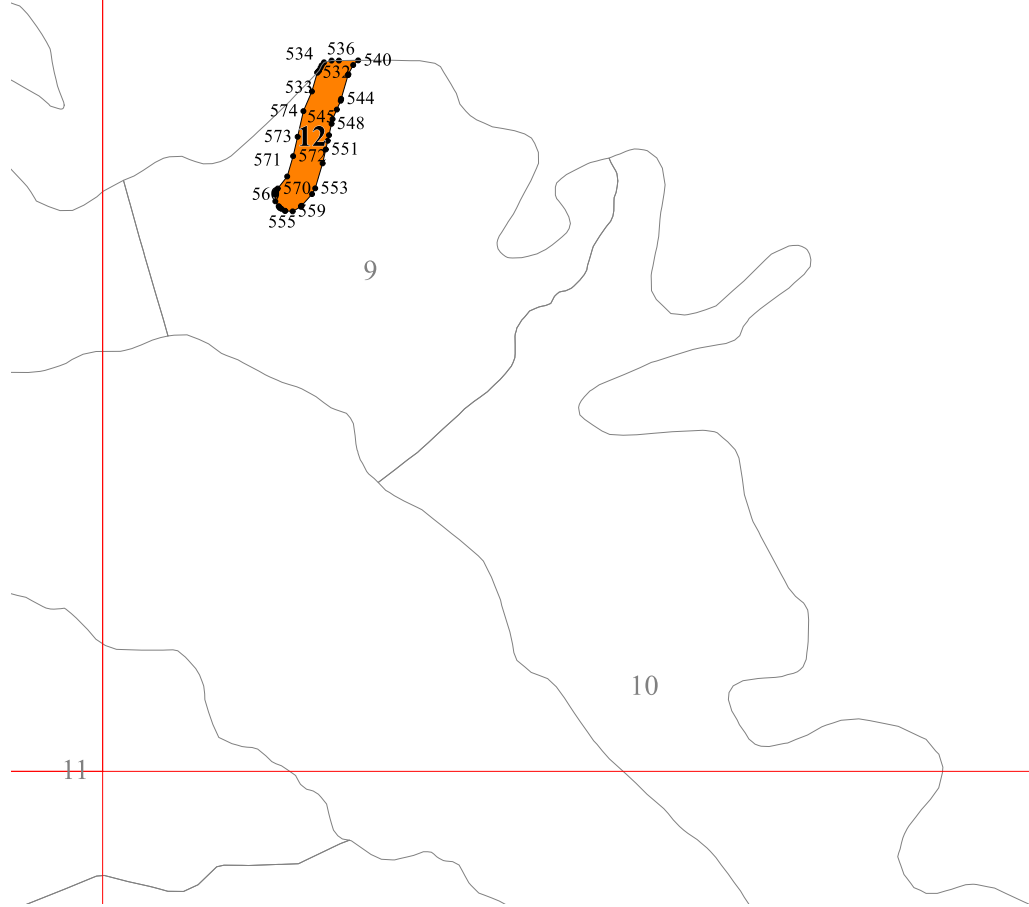

3

11

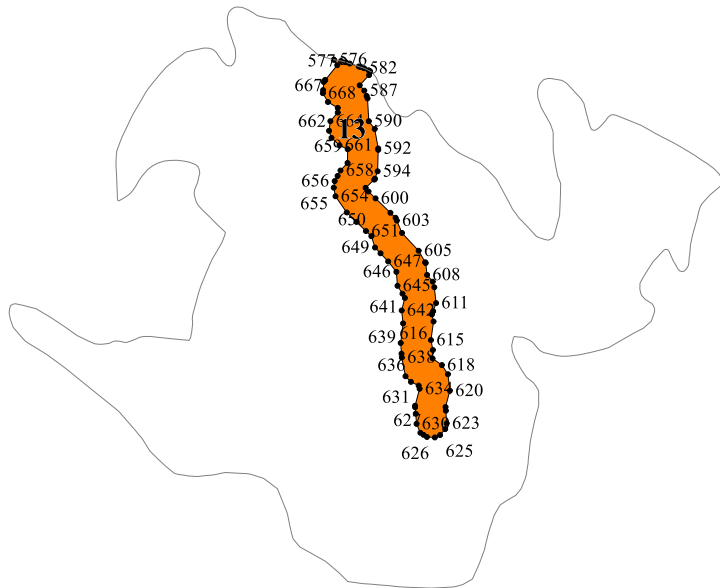

4

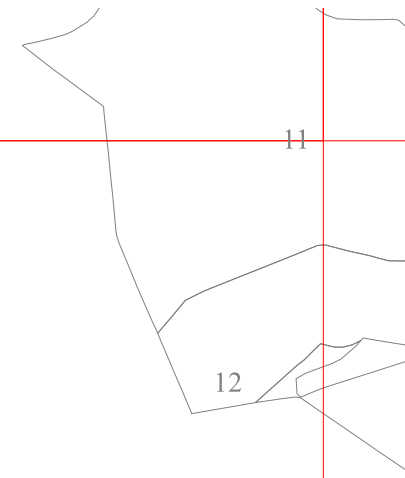

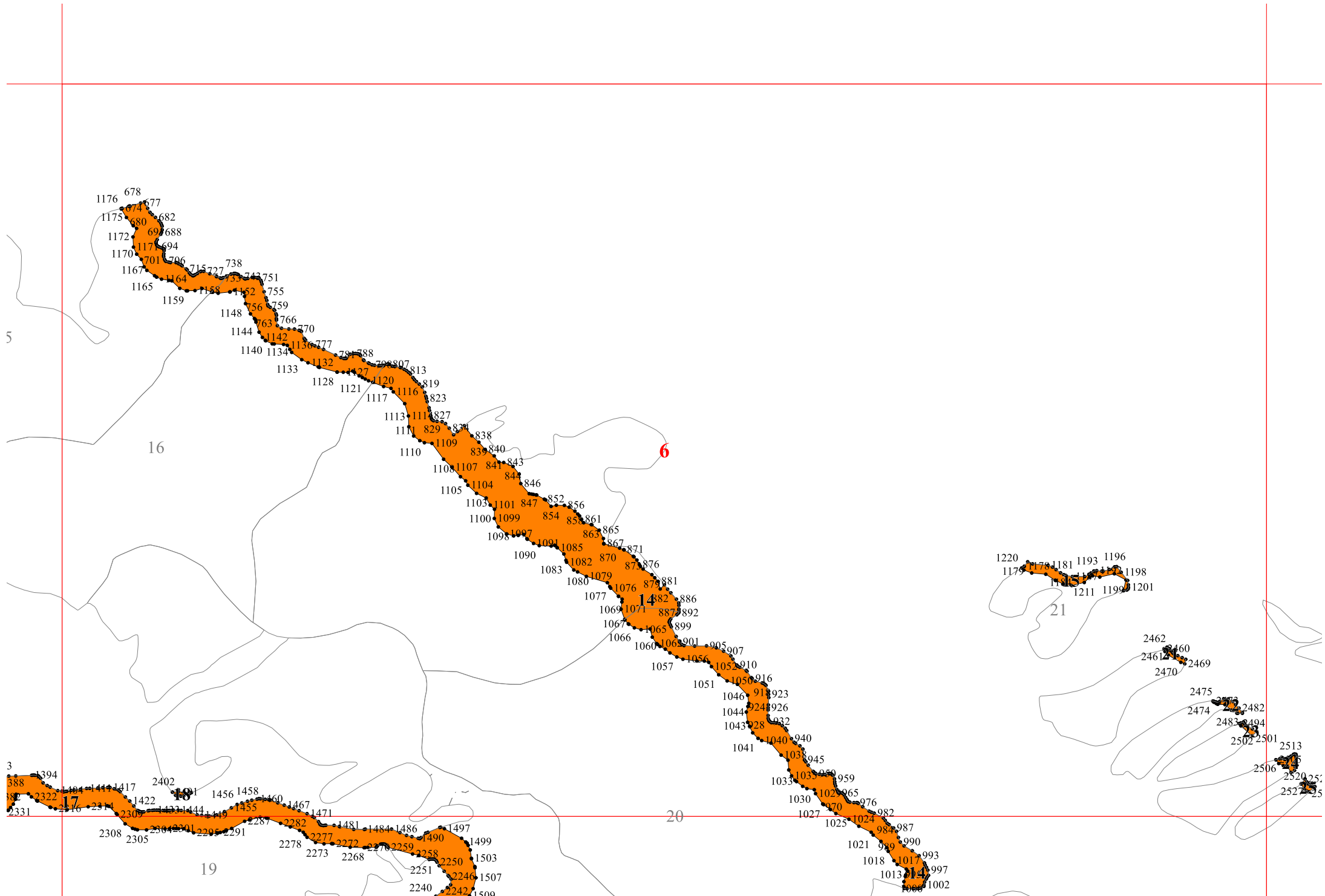

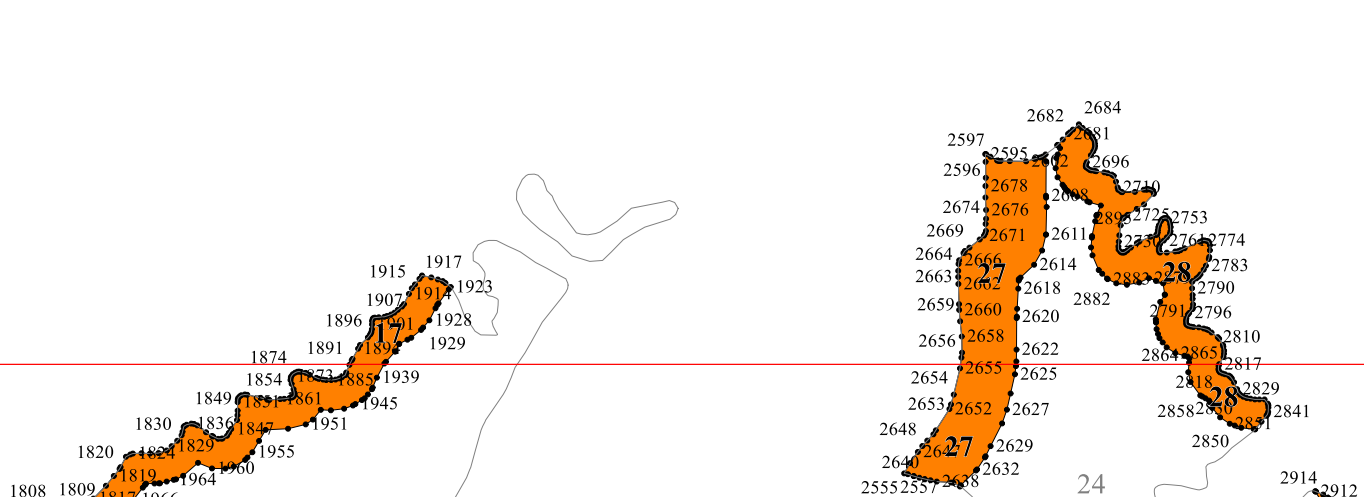

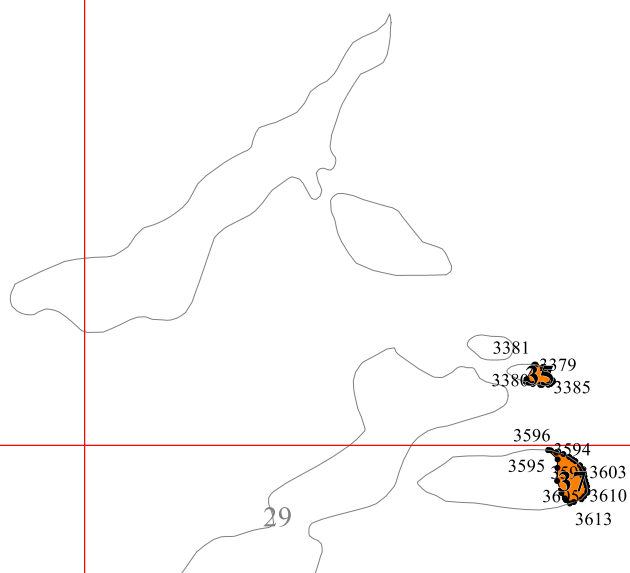

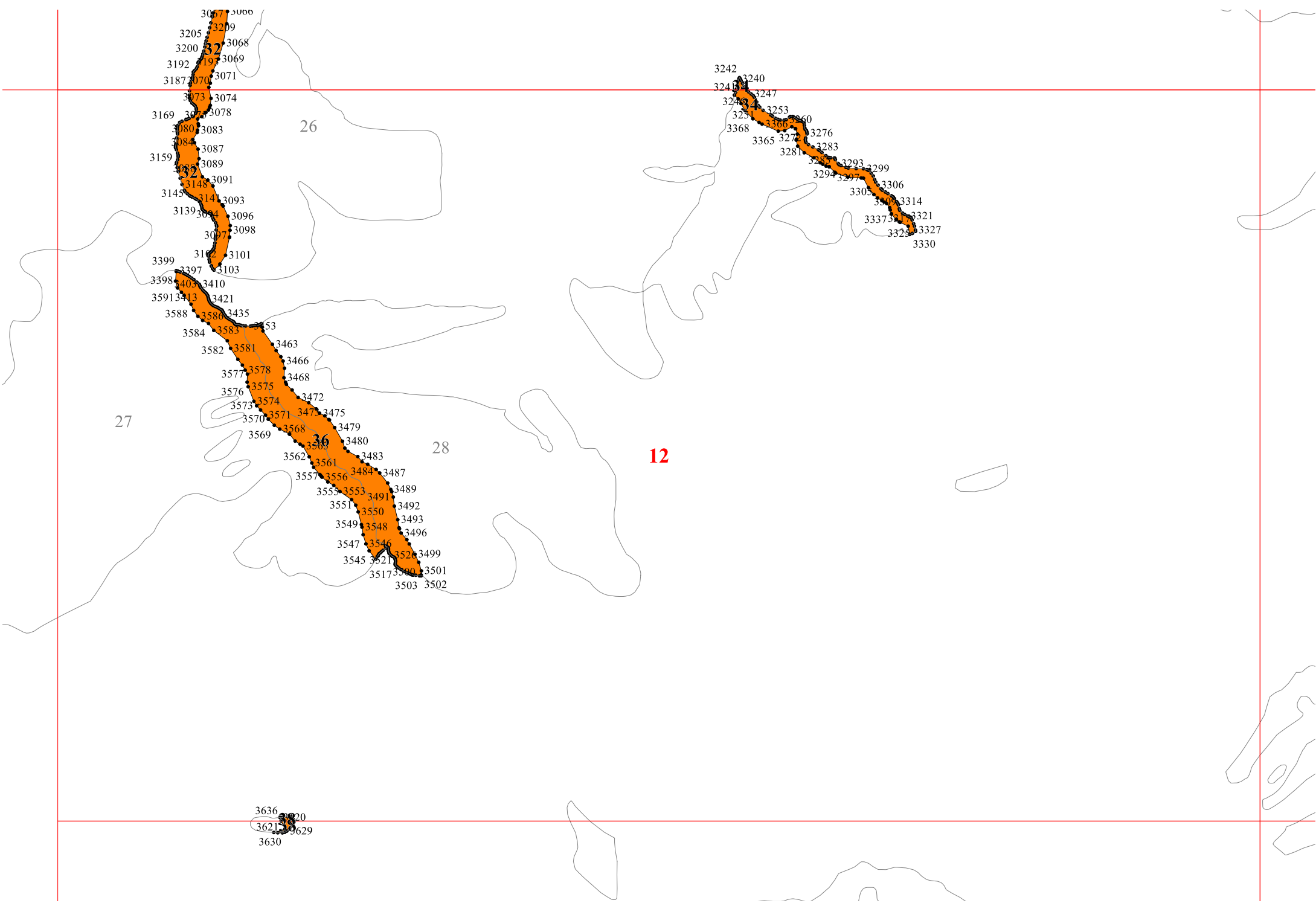

26

27

28

12

3636
3621
3629
3630

38

3067 3060
3205 3209
3200 3068
3192 3069
3187 3071

3073 3074
3169 3078
3080 3083
3084 3087
3159 3089
3148 3091
3145 314 3093
3139 3094 3096
3097 3098

3399 3102 3101
3398 3103
3398 3403 3410
3591 3413 3421

3588 3580 3435
3584 3583 3453
3582 3581 3463

3577 3578 3466
3575 3468
3576 3574 3472
3573 3574 3475

3570 3571 3473 3475
3569 3568 3479
3562 3561 3480
3557 3556 3483

3555 3553 3487
3551 3489
3550 3491
3549 3548 3492
3549 3548 3493

3547 3546 3496
3545 3521 3526 3499
3517 3500 3501
3503 3502

3242 3240
3241 3247
3248 3253
3251 3260
3368 3366 3276
3365 3272 3283
3281 3280 3293 3299
3294 3297 3306
3305 3314
3337 3321
3325 3327
3330

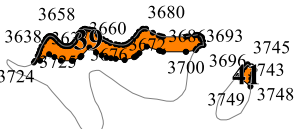
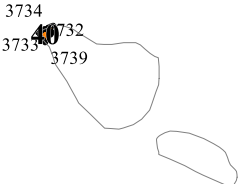
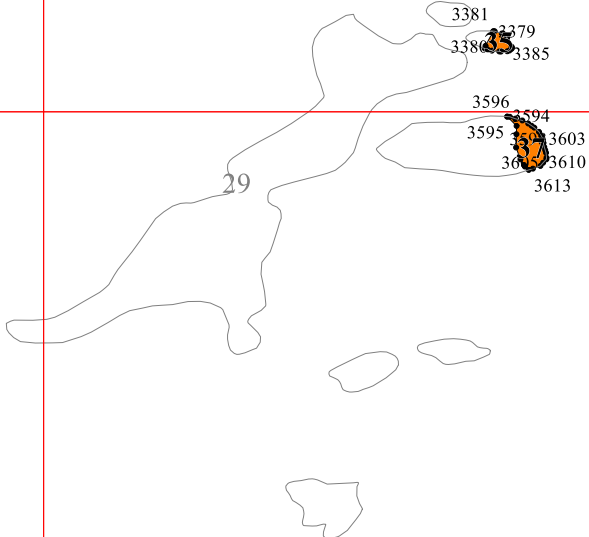

Ud
U

3636
3621
3629
3630

31

14

3827 3832 3825 3821 3818 3817 3849 3844 3813 3853 3815 3815 3848 3754 3755 3809 3812 3753 3809 3754 3755 3804 3761 3760 3804 3766 3765 3800 3769 3771 3774 3776 3776 3776 3791 3782 3784 3785 3869 3788 3860 3861 3868 3859 3865 3862 3863

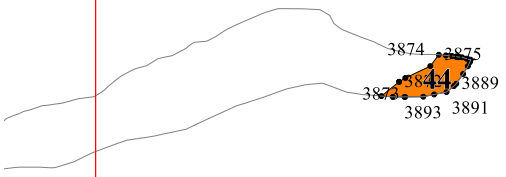
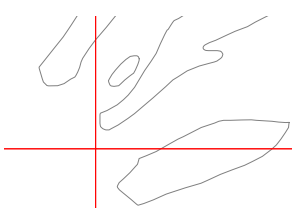

15

3861
3865



16

3913
3912 3911 3916 3929
3918 3917 3939
3940 3944
3945 3946

33

17

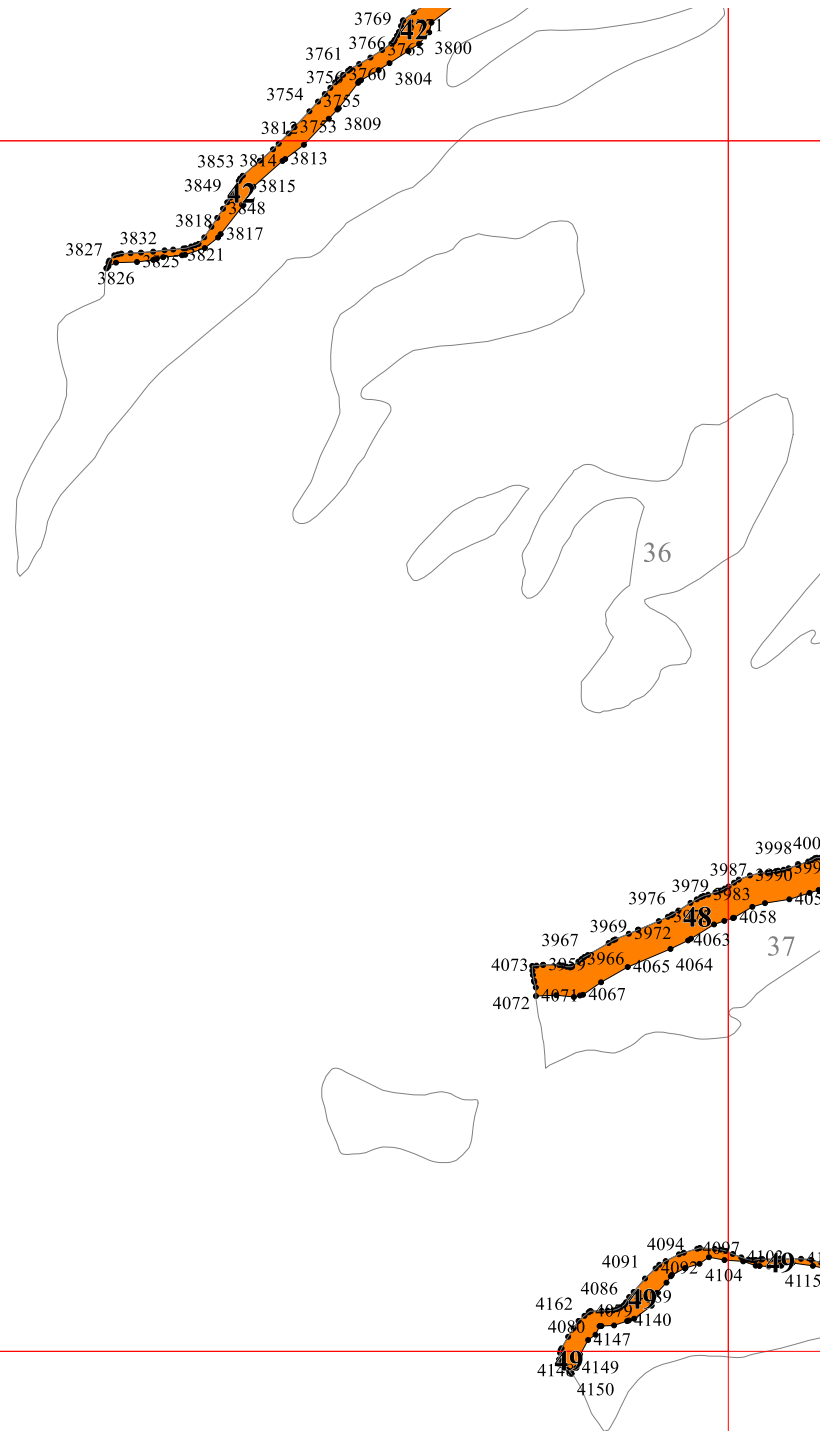



18

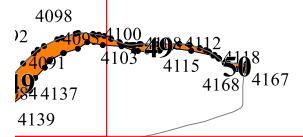
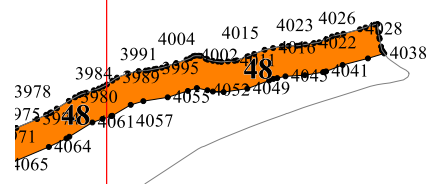

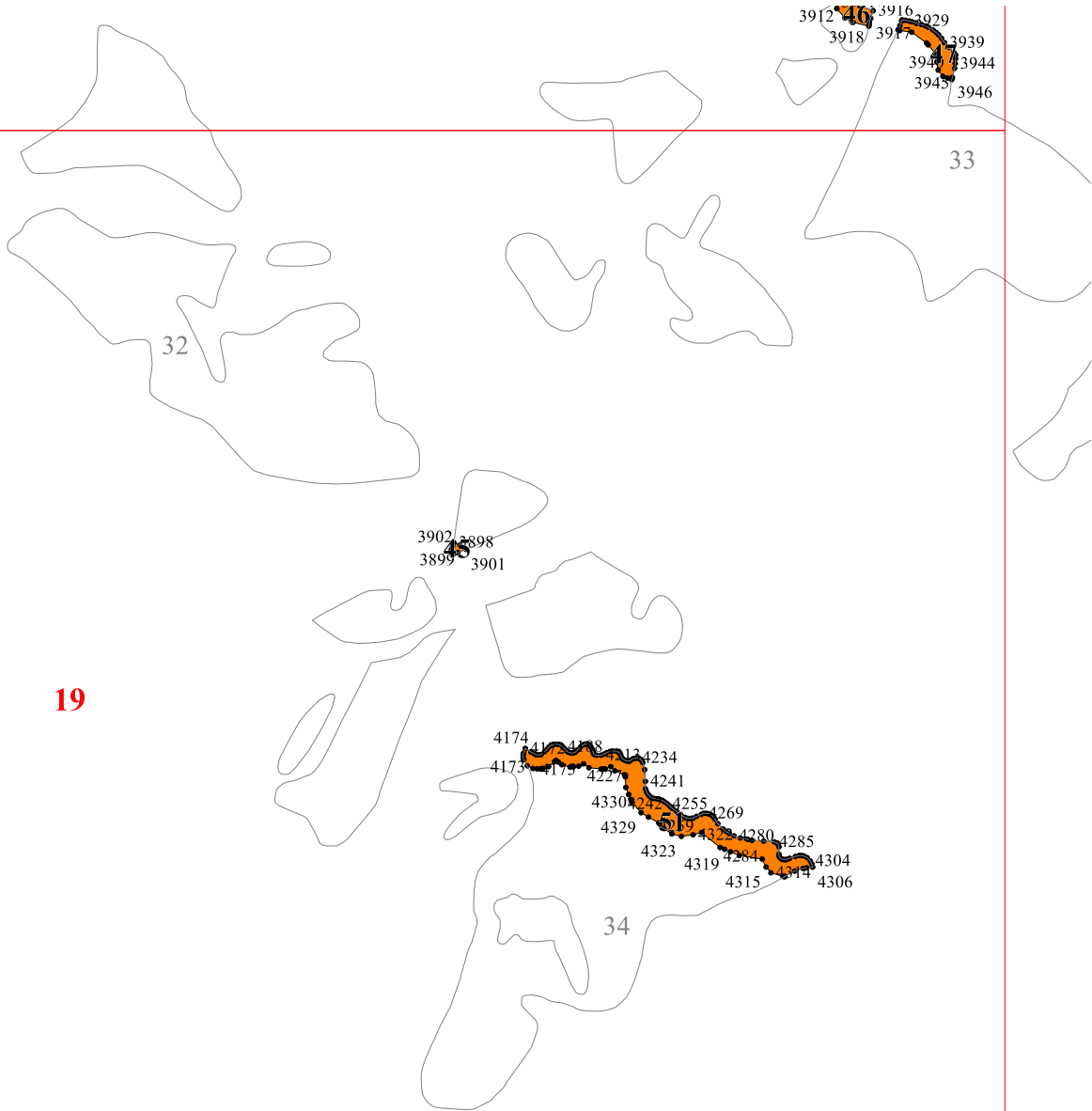

19

32

33

34

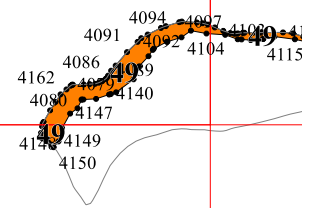

21

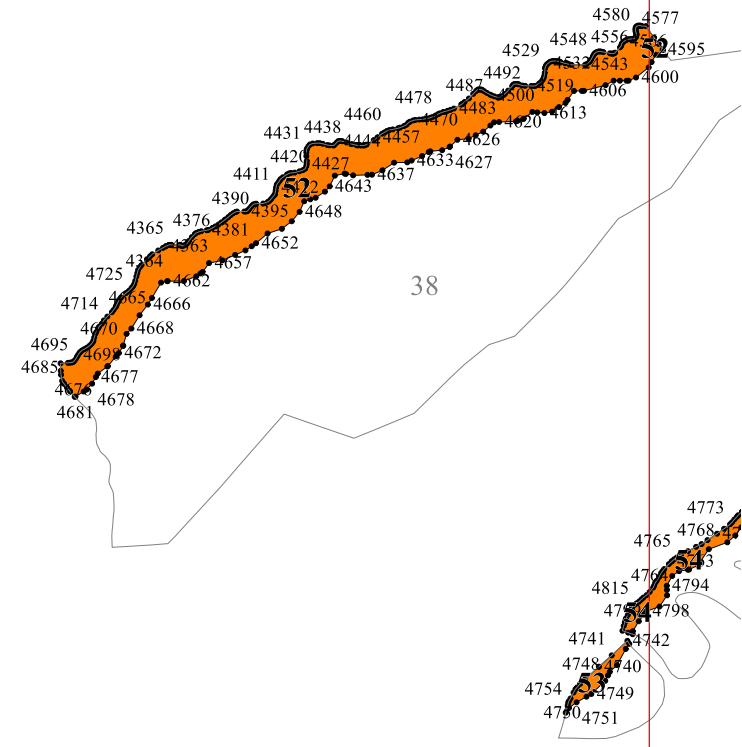

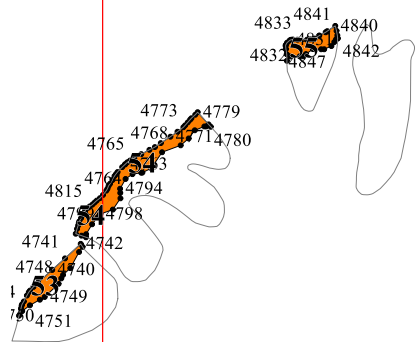
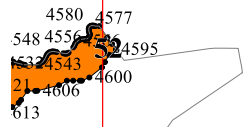

23

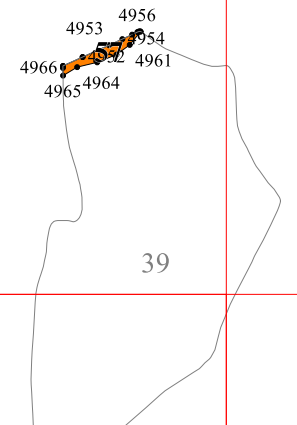
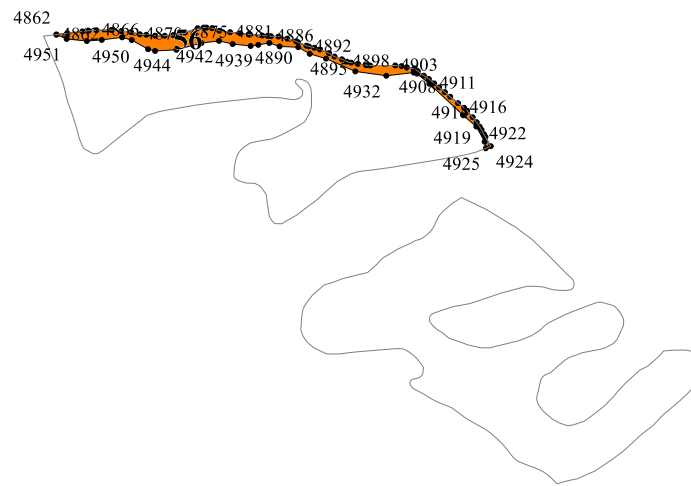

39

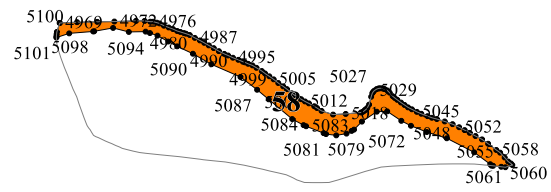

24



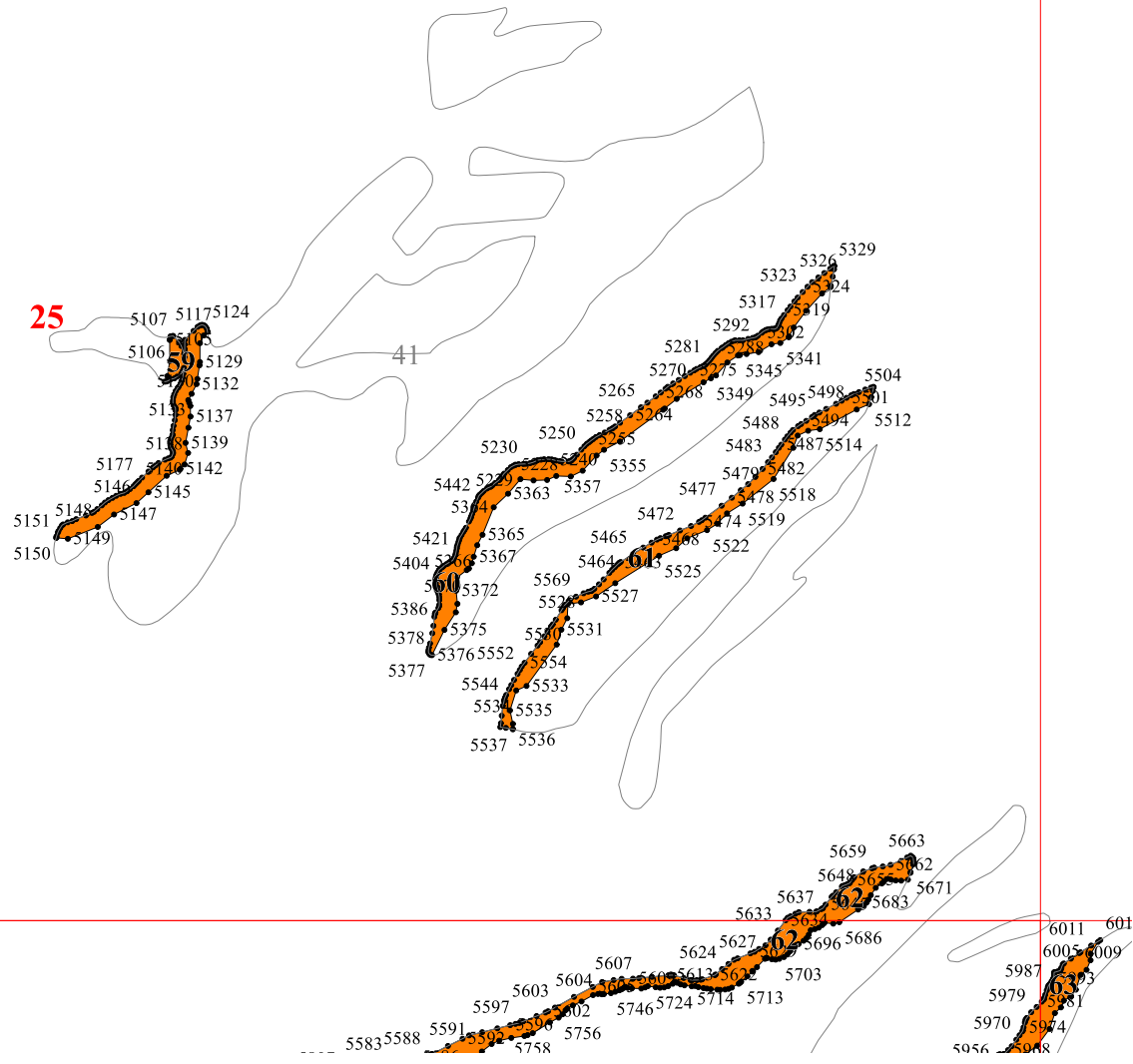

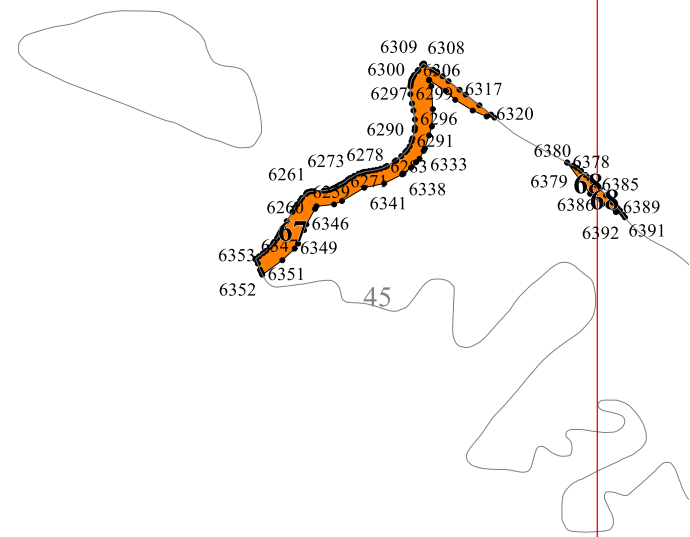



28